

FX_{2N}

FX_{2N}-2LC SPECIAL FUNCTION BLOCK

USER'S GUIDE

JY992D85601C

Cautions on Safety

(Make sure to read this paragraph before using the unit.)

Thoroughly read this manual, a separate USER'S MANUAL and all attached documents of the connected programmable controller (hereafter referred to as "PLC") and other related units before starting installation, operation and inspection/maintenance of the temperature control block. Acquire the knowledge on equipment, the information on safety and all cautions before using the temperature control block. In this instruction manual, cautions on safety are classified as "DANGER" or "CAUTION".

 This symbol indicates that incorrect handling may generate a dangerous situation which may lead to death or serious injury.

 This symbol indicates that incorrect handling may generate a dangerous situation which may lead to medium or minor injury or physical damage.

Even an item classified as "CAUTION" may lead to a severe result depending on the situation. Each item describes important information. Make sure to observe each item marked with "DANGER" or "CAUTION".

Carefully store the instruction manual offered together with the temperature control block so that the operator can refer to it at any time necessary. Make sure to deliver the instruction manual to the end user.

We appreciate it very much that you have purchased the temperature control block FX_{2N}-2LC for Mitsubishi programmable controller.

This manual describes handling of the MELSEC-F Series Temperature Control Block FX_{2N}-2LC.

Thoroughly read this manual and other manuals of related products, and sufficiently understand the specifications before use.

Make sure to deliver this manual to the end user.

Brand and product names described by/in this manual are trademarks or registered trademark of the irrelative ownes.

Related Manuals

When you using the FX_{2N}-2LC for the first time, a separate FX_{2N}-2LC USER'S MANUAL is required. Make sure to obtain the USER'S MANUAL from the dealer from which you have purchased the FX_{2N}-2LC, and safely use the FX_{2N}-2LC.

Manual name	Manual No.	Supplied with product or separately supplied	Description
FX _{2N} -2LC USER'S MANUAL	JY992D85601	Additional Manual	Describes the specification, wiring, installation of FX _{2N} -2LC.
FX _{2N} HARDWARE MANUAL	JY992D66301	Supplied with product	Describes the specification, wiring and installation of FX _{2N} series PLC.
FX _{2NC} HARDWARE MANUAL	JY992D76401	Supplied with product	Describes the specification, wiring and installation of FX _{2NC} series PLC.
FX _{3U} Series HARDWARE MANUAL	JY997D18801	Supplied with product	Describes the specification, wiring and installation of FX _{3U} series PLC.
FX _{3U} Series User's Manual - Hardware Edition	JY997D16501	Additional Manual	Describes the specification, wiring and installation of FX _{3U} series PLC.
FX SERIES PROGRAMMING MANUAL II	JY992D88101	Additional Manual	Describes the instructions of FX _{1S} /FX _{1N} /FX _{2N} /FX _{2NC} series PLC.
FX _{3U} /FX _{3UC} Series Programming Manual - Basic & Applied Instruction Edition	JY997D16601	Additional Manual	This manual explains the installations of FX _{3U} /FX _{3UC} series PLC.

If necessary, obtain them from the dealer from which you have purchased the FX_{2N}-2LC.

1. Outline of Product



Cautions on design

- Install a safety circuit outside the PLC so that the entire system conservatively operates even if an abnormality occurs in the external power supply or a failure occurs in the PLC. If the safety circuit is installed inside the PLC, malfunction and erroneous output may cause accidents. Make sure to construct an emergency stop circuit, protection circuit, interlock circuit to prevent damage to a machine or instrument outside the PLC.
- When the PLC or FX2N-2LC detects an abnormality such as a watch dog timer error or input value error by the self-diagnosis circuit, and all outputs turn off. When an abnormality occurs in the I/O control area which cannot be detected by the CPU in the PLC, output control may be disabled. Design external circuits and the structure so that the entire system conservatively operates in such cases.
- When a failure occurs in a relay, transistor, triac, etc. in the FX2N-2LC or output unit of PLC, outputs may keep ON or OFF. For output signals which may lead to severe accidents, design external circuits and the structure so that the entire system conservatively operates.



Caution on disposal

- When disposing of the unit, treat it as industrial waste.

The temperature control block FX2N-2LC (hereafter referred to as "temperature control block" or "FX2N-2LC") equipped with two temperature input points and two transistor (open collector) output points is a special block to control outputs of temperature inputs from thermocouples and platinum resistance thermometer bulbs by PID control.

Connect the FX2N-2LC to the FX1N/FX2N/FX2NC/FX3U Series PLC.

- As input sensors, two thermocouples, two platinum resistance thermometer bulbs or one thermocouple and one platinum resistance thermometer bulb are available.
- Data can be read and written using FROM/TO instructions when the FX2N-2LC is connected to the FX1N/FX2N/FX2NC/FX3U Series PLC. (The FX2N-2LC performs arithmetic operation for PID control and output control. The PLC does not have to perform such control.)
- Disconnection of heaters can be detected by current detection.
- The proportional band, the integral time and the derivative time can be easily set by auto tuning.
- Channels are isolated from each other.

2. Outside Dimension

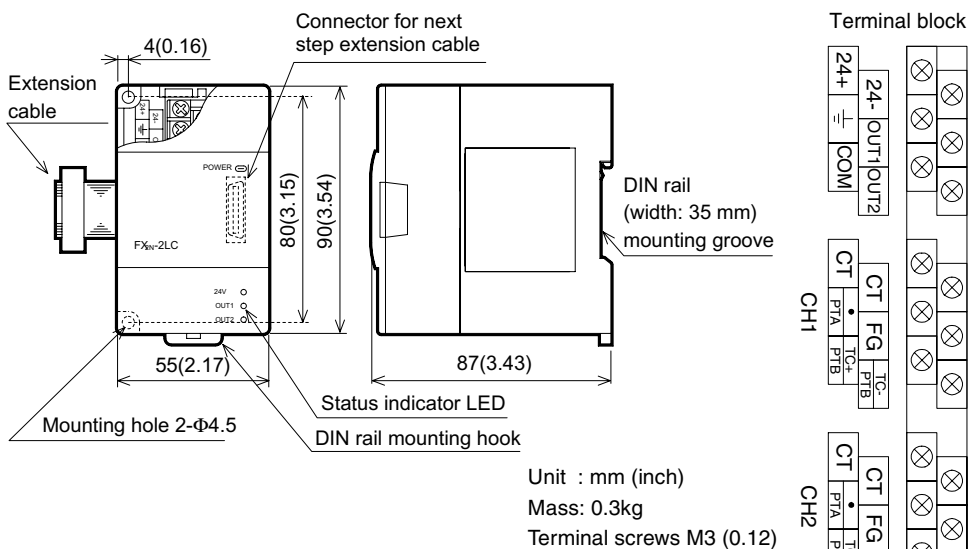

3. Installation Method



Cautions on installation

- Use the unit in the environment for the general specifications described in the manual. Never use the unit in a place with dust, soot, conductive dust, corrosive gas or flammable gas, a place exposed to high temperature, dew condensation or rain and wind or a place exposed to vibration or impact. If the unit is used in such a place, electrical shock, fire, malfunction, damage in the product or deterioration of the product may be caused.
- Never drop cutting chips or electric wire chips into the ventilation window of the FX2N-2LC while drilling screw holes or wiring cables. Such chips may cause fire, failure or malfunction.
- After finishing installation, remove a dust preventing sheet adhered on the ventilation window of the PLC and the FX2N-2LC. If the sheet remains attached, fire, failure or malfunction may be caused.
- Securely connect connection cables such as extension cables and memory cassettes to specified connectors. Imperfect contact may cause malfunction.

The FX2N-2LC can be installed on the right side of an FX1N/FX2N/FX2NC/FX3U Series PLC main unit or extension unit.

The FX2N-2LC can be attached with a DIN rail DIN46277 (width: 35 mm) or directly attached to a panel surface with screws (M4).

3.1 Installation on DIN rail

Align the upper side of the DIN rail mounting groove of the FX2N-2LC with a DIN rail DIN46277 (width: 35 mm) (①), and push it on the DIN rail.(②)

When removing the FX2N-2LC, pull out downward the DIN rail mounting hook.(③), and remove from DIN rail.(④)

When attached to DIN rail

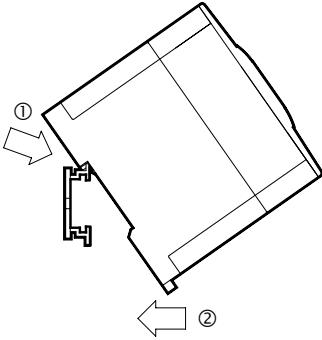

When removed from DIN rail

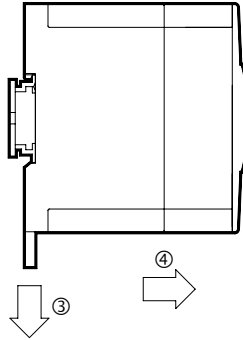

3.2 Direct installation on panel surface

Screw-tighten the FX2N-2LC with M4 screws to a panel surface using two (upper and lower) mounting holes provided on the left side of the FX2N-2LC.

Assure the interval of 1 to 2 mm between a unit or block installed on the left side of the FX2N-2LC.

4. Connection to PLC Main Unit

Connect the FX2N-2LC to the PLC main unit with an extension cable.

FX2N-2LC units are treated as special units of the PLC, and the special unit No. 0 to 7 is automatically assigned to each FX2N-2LC unit from the one nearest to the PLC main unit. (These unit Nos. are used in FROM/TO instructions.)

One FX2N-2LC unit occupies eight I/O points in the PLC main unit.

For the details of I/O assignment in the PLC, refer to the manual of the PLC main unit.

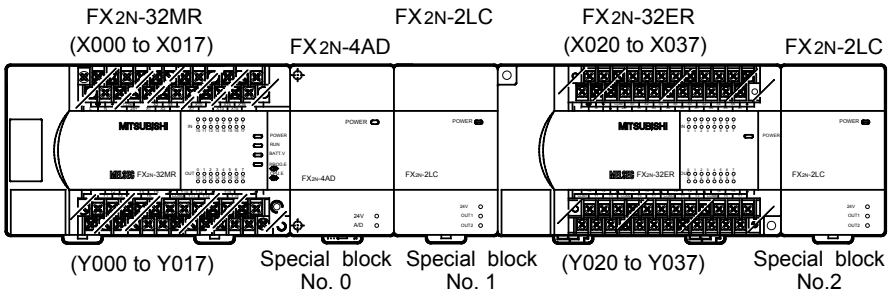

- Please check power supply specifications to decide the number of FX2N-2LC units that can be connected to the FX1N/FX2N/FX2NC/FX3U extension unit and PLC.
- To connect the FX2N-2LC unit to the FX2NC Series PLC, the interface FX2NC-CNV-IF is required.
- For extension, an extension cable FX0N-65EC (650 mm) and the FX2N-CNV-BC sold separately are required. Only one FX0N-65EC can be used in one system.

() indicates the I/O No.

5. Wiring



Cautions on wiring

- Make sure to shut down the power supplies of all phases on the outside before starting installation or wiring.
If the power supplies are not shut down, you may receive an electrical shock or the unit may be damaged.
 - As to loads, such as a connector for normal rotation and a connector for reverse rotation, which are dangerous when turning on at the same time, make sure to interlock them outside the PLC in addition to interlocking of them in a program in the PLC.
- !**
- Correctly connect the power cable of the FX2N-2LC and the PLC as described in this manual. If the AC power supply is connected to a DC I/O terminal or DC power terminal, the PLC may be damaged.
 - Perform Class D grounding with an electric wire of 2 mm² or more to the grounding terminal in the FX2N-2LC and the PLC. However, never perform common grounding with a strong power system.

When a temperature sensor is a thermocouple

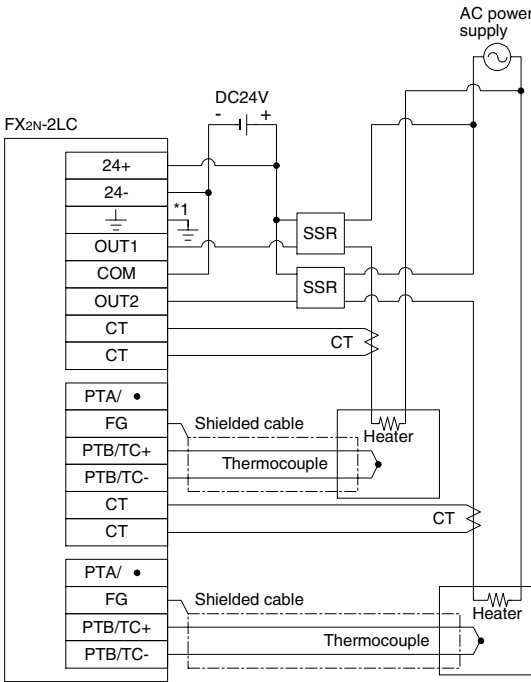

*1 Connect the ground terminals of the FX2N-2LC unit and the main unit. Use class D grounding on the main unit.

- Use the compensating cable when you use the thermo couple.

When a temperature sensor is a resistance thermometer bulb

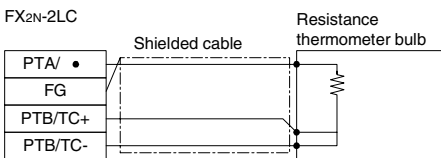

- The temperature sensor must use three line type. The resistance of the lead wire is a little, and use the wire rod without the resistance difference between three lines.
- Secure the termination using a tightening torque of 0.5 to 0.8N·m

6. Specifications

6.1 General specifications

Item	Specifications
Withstand voltage	500V AC for 1 minute (between analog input terminal and grounding terminal)

Other General specifications are equivalent to those for the PLC main unit. Refer to the manual of the PLC main unit.

6.2 Power supply specifications

Item	Specifications
Driving power supply	24V DC (-15% to +10% maximum), input from driving power supply terminal
Power supply for communication	5V DC (supplied from inside of PLC main unit)
Current consumption	24V DC, 55 mA and 5V DC, 70 mA
Insulation method	Analog input area and PLC are insulated by photocoupler. Power supply and analog input are insulated by DC/DC converter. (Channels are insulated from each other.)
Number of occupied I/O points	8 points in total (including input points and output points)

6.3 Performance specifications

Item		Description
Control method		Two-position control, PID control (with auto tuning function), PI control
Control operation period		500ms
Set temperature range		Equivalent to input range
Heater disconnection detection		Alarm is detected by buffer memory (Variable within range from 0.0 to 100.0 A.).
Operation mode		0: Measured value monitor 1: Measured value monitor + Temperature alarm 2: Measured value monitor + Temperature alarm + Control (selected by buffer memory)
Self-diagnosis function		Adjustment data check, input value check, watch dog timer check.
Memory		Built-in EEPROM (Number of times of overwrite: 100,000 times)
Indication	POWER	Lit (green): While 5V power is supplied Extinguished: While 5V power is not supplied
	24V	Lit (red): While 24V power is supplied Extinguished: While 24V power is not supplied
	OUT1	Lit (red): While control output 1 is ON Extinguished: While control output 1 is OFF
	OUT2	Lit (red): While control output 2 is ON Extinguished: While control output 2 is OFF

6.4 Input specifications

Item		Description	
Temperature input	Number of input points	2 points	
	Input type	Thermocouple	K, J, R, S, E, T, B, N, PLII, WRe5-26, U, L, JIS C 1602-1995
		Resistance thermometer bulb	3-wire Pt100 JIS C 1604-1997, JPt100 JIS C 1604-1981
	Measurement precision	Ambient temperature 23 °C ± 5 °C : ± 0.3% of range span ± 1 digit. Ambient temperature 0 °C to 55 °C : ± 0.7% of range span ± 1 digit. However, 0 to 399 °C (0 to 799 °F) in B inputs as well as 0 to 32 °F in PLII and WRe5-26 inputs are outside precision guarantee range.	
	Cold contact temperature compensation error	Within ±1.0 °C However, within ± 2.0 °C while input value is -150 to -100 °C within ± 3.0 °C while input value is -200 to -150 °C	
	Resolution	0.1 °C (0.1°F) or 1 °C(1°F) (Varies depending on input range of used sensors.)	
	Sampling period	500ms	
	Effect of external resistance	Approx. 0.35 μV/Ω	
	Input impedance	1 MΩ or more	
	Sensor current	Approx. 0.3 mA	
	Allowable input lead wire resistance	10 Ω or less	
	Operation when input is disconnected	Upscale	
	Operation when input is short-circuited	Downscale	
CT input	Number of inputs	2 points	
	Current detector	CTL-12-S36-8 or CTL-6-P-H (manufactured by U.R.D. Co., Ltd.)	
	Heater current measurement value	When CTL-12 is used: 0 to 100A When CTL-6 is used: 0 to 30A	
	Measurement precision	Larger one between ± 5% of input value and 2 A (excluding precision of current detector)	
	Sampling period	1 second	

6.5 Input range

Sensor type	K	J	R	S
Input range	-200.0 to 200.0 °C -100.0 to 400.0 °C -100 to 1300 °C -100 to 800 °F -100 to 2400 °F	-200.0 to 200.0 °C -100.0 to 400.0 °C -100.0 to 800.0 °C -100 to 1200 °C -100 to 1600 °F -100 to 2100 °F	0 to 1700 °C 0 to 3200 °F	0 to 1700 °C 0 to 3200 °F

Sensor type	E	T	B	N
Input range	-200.0 to 200.0 °C 0 to 1000 °C 0 to 1800 °F	-200.0 to 200.0 °C -200.0 to 400.0 °C 0.0 to 400.0 °C -300.0 to 400.0 °F -300.0 to 700.0 °F 0.0 to 700.0 °F	0 to 1800 °C 0 to 3000 °F	0 to 1300 °C 0 to 2300 °F

Sensor type	PLII	WRe5-26	U	L
Input range	0 to 1200 °C 0 to 2300 °F	0 to 2300 °C 0 to 3000 °F	-200.0 to 600.0 °C -300.0 to 700.0 °F	0.0 to 900.0 °C 0 to 1600 °F

Sensor type	JPt100	Pt100
Input range	-50.0 to 150.0 °C -200.0 to 500.0 °C -300.0 to 300.0 °F -300 to 900 °F	-50.0 to 150.0 °C -200.0 to 600.0 °C -300.0 to 300.0 °F -300 to 1100 °F

- When B is used, 0 to 399 °C (0 to 799 °F) is outside the precision guarantee range.
- When PLII is used, 0 to 32 °F is outside the precision guarantee range.
- When WRe5-26 is used, 0 to 32 °F is outside the precision guarantee range.

6.6 Output specifications

Item	Description
Number of output points	2 points
Output method	Open collector transistor output
Rated load voltage	5 to 24V DC
Maximum load voltage	30V DC or less
Maximum load current	100mA
Leak current in OFF status	0.1 mA or less
Maximum voltage drop in ON status	2.5V (maximum) or 1.0V (typical) at 100 mA
Control output cycle	30 seconds (Variable within range from 1 to 100 seconds)

Guidelines for the safety of the user and protection of the FX2N-2LC

- This manual has been written to be used by trained and competent personnel. This is defined by the European directives for machinery, low voltage and EMC.
- If in doubt at any stage during the installation of the FX2N-2LC always consult a professional electrical engineer who is qualified and trained to the local and national standards. If in doubt about the operation or use of the FX2N-2LC please consult the nearest Mitsubishi Electric distributor.
- Under no circumstances will Mitsubishi Electric be liable or responsible for any consequential damage that may arise as a result of the installation or use of this equipment.
- All examples and diagrams shown in this manual are intended only as an aid to understanding the text, not to guarantee operation. Mitsubishi Electric will accept no responsibility for actual use of the product based on these illustrative examples.
- Owing to the very great variety in possible application of this equipment, you must satisfy yourself as to its suitability for your specific application.

Manual number : JY992D85601

Manual revision : C

Date : March 2007

 **MITSUBISHI ELECTRIC CORPORATION**

HEAD OFFICE : TOKYO BUILDING, 2-7-3 MARUNOUCHI, CHIYODA-KU, TOKYO 100-8310, JAPAN
HIMEJI WORKS : 840, CHIYODA CHO, HIMEJI, JAPAN

FX2N

FX2N-2LC SPECIAL FUNCTION BLOCK

USER'S GUIDE

JY992D85601C

Cautions on Safety

(Make sure to read this paragraph before using the unit.)

Thoroughly read this manual, a separate USER'S MANUAL and all attached documents of the connected programmable controller (hereafter referred to as "PLC") and other related units before starting installation, operation and inspection/maintenance of the temperature control block. Acquire the knowledge on equipment, the information on safety and all cautions before using the temperature control block. In this instruction manual, cautions on safety are classified as "DANGER" or "CAUTION".

This symbol indicates that incorrect handling may generate a dangerous situation which may lead to death or serious injury.

This symbol indicates that incorrect handling may generate a dangerous situation which may lead to medium or minor injury or physical damage.

Even an item classified as "CAUTION" may lead to a severe result depending on the situation. Each item describes important information. Make sure to observe each item marked with "DANGER" or "CAUTION".

Carefully store the instruction manual offered together with the temperature control block so that the operator can refer to it at any time necessary. Make sure to deliver the instruction manual to the end user.

We appreciate it very much that you have purchased the temperature control block FX2N-2LC for Mitsubishi programmable controller.

This manual describes handling of the MELSEC-F Series Temperature Control Block FX2N-2LC.

Thoroughly read this manual and other manuals of related products, and sufficiently understand the specifications before use.

Make sure to deliver this manual to the end user.

Brand and product names described by/in this manual are trademarks or registered trademark of the irrespctive ownes.

Related Manuals

When you using the FX2N-2LC for the first time, a separate FX2N-2LC USER'S MANUAL is required. Make sure to obtain the USER'S MANUAL from the dealer from which you have purchased the FX2N-2LC, and safely use the FX2N-2LC.

Manual name	Manual No.	Supplied with product or separately supplied	Description
FX2N-2LC USER'S MANUAL	JY992D85601	Additional Manual	Describes the specification, wiring, installation of FX2N-2LC.
FX2N HARDWARE MANUAL	JY992D66301	Supplied with product	Describes the specification, wiring and installation of FX2N series PLC.
FX2NC HARDWARE MANUAL	JY992D76401	Supplied with product	Describes the specification, wiring and installation of FX2NC series PLC.
FX3U Series HARDWARE MANUAL	JY997D18801	Supplied with product	Describes the specification, wiring and installation of FX3U series PLC.
FX3U Series User's Manual - Hardware Edition	JY997D16501	Additional Manual	Describes the specification, wiring and installation of FX3U series PLC.
FX SERIES PROGRAMMING MANUAL II	JY992D88101	Additional Manual	Describes the instructions of FX1S/ FX1N/FX2N/FX2NC series PLC.
FX3U/FX3UC Series Programming Manual - Basic & Applied Instruction Edition	JY997D16601	Additional Manual	This manual explains the installations of FX3U/FX3UC series PLC.

If necessary, obtain them from the dealer from which you have purchased the FX2N-2LC.

1. Outline of Product

Cautions on design

- Install a safety circuit outside the PLC so that the entire system conservatively operates even if an abnormality occurs in the external power supply or a failure occurs in the PLC. If the safety circuit is installed inside the PLC, malfunction and erroneous output may cause accidents. Make sure to construct an emergency stop circuit, protection circuit, interlock circuit to prevent damage to a machine or instrument outside the PLC.
- When the PLC or FX2N-2LC detects an abnormality such as a watch dog timer error or input value error by the self-diagnosis circuit, and all outputs turn off. When an abnormality occurs in the I/O control area which cannot be detected by the CPU in the PLC, output control may be disabled. Design external circuits and the structure so that the entire system conservatively operates in such cases.
- When a failure occurs in a relay, transistor, triac, etc. in the FX2N-2LC or output unit of PLC, outputs may keep ON or OFF. For output signals which may lead to severe accidents, design external circuits and the structure so that the entire system conservatively operates.

Caution on disposal

- When disposing of the unit, treat it as industrial waste.

The temperature control block FX2N-2LC (hereafter referred to as "temperature control block" or "FX2N-2LC") equipped with two temperature input points and two transistor (open collector) output points is a special block to control outputs of temperature inputs from thermocouples and platinum resistance thermometer bulbs by PID control.

Connect the FX2N-2LC to the FX1N/FX2N/FX2NC/FX3U Series PLC.

- As input sensors, two thermocouples, two platinum resistance thermometer bulbs or one thermocouple and one platinum resistance thermometer bulb are available.
- Data can be read and written using FROM/TO instructions when the FX2N-2LC is connected to the FX1N/FX2N/FX2NC/FX3U Series PLC. (The FX2N-2LC performs arithmetic operation for PID control and output control. The PLC does not have to perform such control.)
- Disconnection of heaters can be detected by current detection.
- The proportional band, the integral time and the derivative time can be easily set by auto tuning.
- Channels are isolated from each other.

2. Outside Dimension

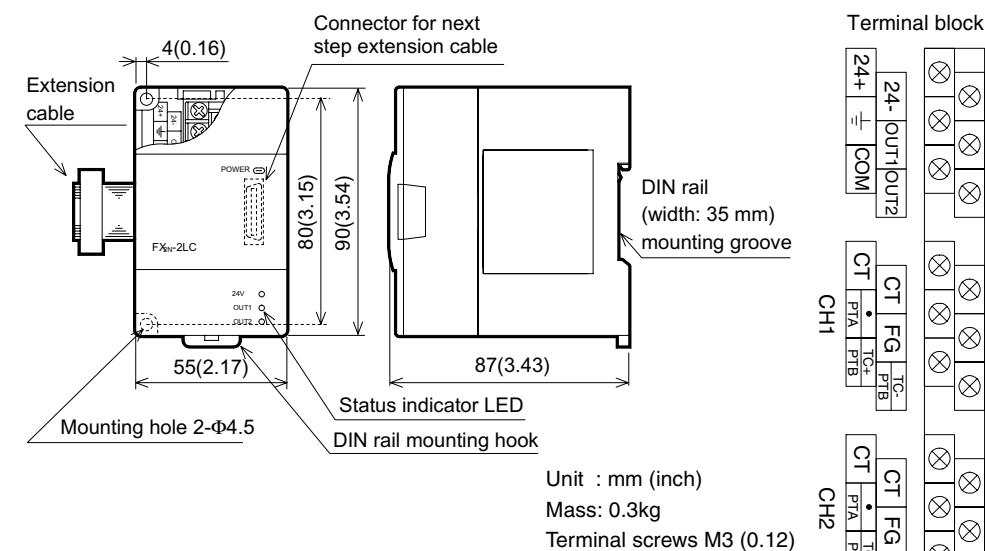

3. Installation Method

Cautions on installation

- Use the unit in the environment for the general specifications described in the manual. Never use the unit in a place with dust, soot, conductive dust, corrosive gas or flammable gas, a place exposed to high temperature, dew condensation or rain and wind or a place exposed to vibration or impact. If the unit is used in such a place, electrical shock, fire, malfunction, damage in the product or deterioration of the product may be caused.
- Never drop cutting chips or electric wire chips into the ventilation window of the FX2N-2LC while drilling screw holes or wiring cables. Such chips may cause fire, failure or malfunction.
- After finishing installation, remove a dust preventing sheet adhered on the ventilation window of the PLC and the FX2N-2LC. If the sheet remains attached, fire, failure or malfunction may be caused.
- Securely connect connection cables such as extension cables and memory cassettes to specified connectors. Imperfect contact may cause malfunction.

The FX2N-2LC can be installed on the right side of an FX1N/FX2N/FX2NC/FX3U Series PLC main unit or extension unit.

The FX2N-2LC can be attached with a DIN rail DIN46277 (width: 35 mm) or directly attached to a panel surface with screws (M4).

3.1 Installation on DIN rail

Align the upper side of the DIN rail mounting groove of the FX2N-2LC with a DIN rail DIN46277 (width: 35 mm) (1), and push it on the DIN rail.(2)

When removing the FX2N-2LC, pull out downward the DIN rail mounting hook.(3), and remove from DIN rail.(4)

When attached to DIN rail

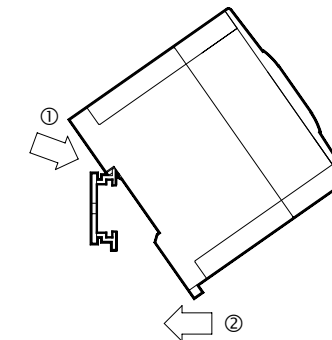

When removed from DIN rail

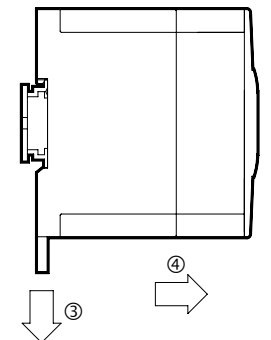

3.2 Direct installation on panel surface

Screw-tighten the FX2N-2LC with M4 screws to a panel surface using two (upper and lower) mounting holes provided on the left side of the FX2N-2LC.

Assure the interval of 1 to 2 mm between a unit or block installed on the left side of the FX2N-2LC.

4. Connection to PLC Main Unit

Connect the FX2N-2LC to the PLC main unit with an extension cable. FX2N-2LC units are treated as special units of the PLC, and the special unit No. 0 to 7 is automatically assigned to each FX2N-2LC unit from the one nearest to the PLC main unit. (These unit Nos. are used in FROM/TO instructions.)

One FX2N-2LC unit occupies eight I/O points in the PLC main unit.

For the details of I/O assignment in the PLC, refer to the manual of the PLC main unit.

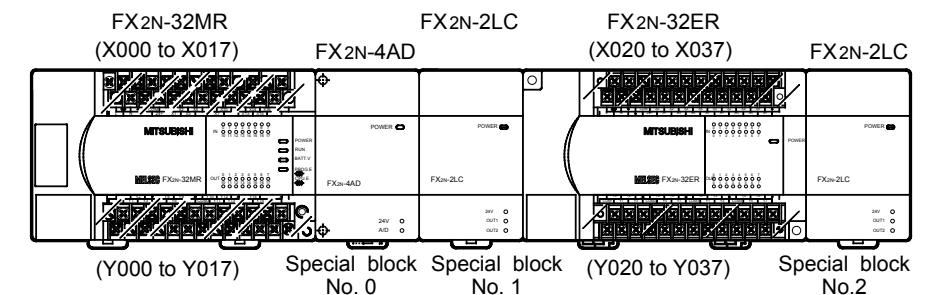

- Please check power supply specifications to decide the number of FX2N-2LC units that can be connected to the FX1N/FX2N/FX2NC/FX3U extension unit and PLC.
- To connect the FX2N-2LC unit to the FX2NC Series PLC, the interface FX2NC-CNV-IF is required.
- For extension, an extension cable FX0N-65EC (650 mm) and the FX2N-CNV-BC sold separately are required. Only one FX0N-65EC can be used in one system.

() indicates the I/O No.

5. Wiring



Cautions on wiring

- Make sure to shut down the power supplies of all phases on the outside before starting installation or wiring. If the power supplies are not shut down, you may receive an electrical shock or the unit may be damaged.
- As to loads, such as a connector for normal rotation and a connector for reverse rotation, which are dangerous when turning on at the same time, make sure to interlock them outside the PLC in addition to interlocking of them in a program in the PLC.
- Correctly connect the power cable of the FX2N-2LC and the PLC as described in this manual. If the AC power supply is connected to a DC I/O terminal or DC power terminal, the PLC may be damaged.
- Perform Class D grounding with an electric wire of 2 mm² or more to the grounding terminal in the FX2N-2LC and the PLC. However, never perform common grounding with a strong power system.

When a temperature sensor is a thermocouple

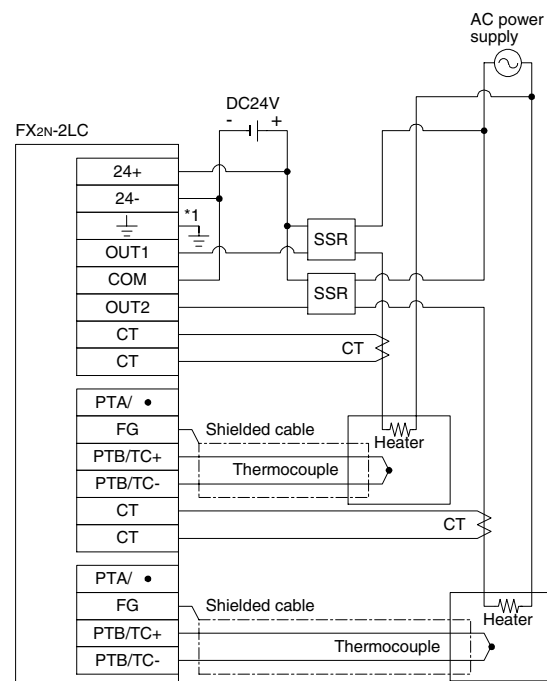

- *1 Connect the ground terminals of the FX2N-2LC unit and the main unit. Use class D grounding on the main unit.
- Use the compensating cable when you use the thermo couple.

When a temperature sensor is a resistance thermometer bulb

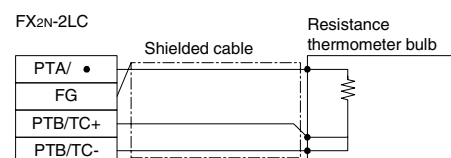

- The temperature sensor must use three line type. The resistance of the lead wire is a little, and use the wire rod without the resistance difference between three lines.
- Secure the termination using a tightening torque of 0.5 to 0.8N·m

6. Specifications

6.1 General specifications

Item	Specifications
Withstand voltage	500V AC for 1 minute (between analog input terminal and grounding terminal)

Other General specifications are equivalent to those for the PLC main unit. Refer to the manual of the PLC main unit.

6.2 Power supply specifications

Item	Specifications
Driving power supply	24V DC (-15% to +10% maximum), input from driving power supply terminal
Power supply for communication	5V DC (supplied from inside of PLC main unit)
Current consumption	24V DC, 55 mA and 5V DC, 70 mA
Insulation method	Analog input area and PLC are insulated by photocoupler. Power supply and analog input are insulated by DC/DC converter. (Channels are insulated from each other.)
Number of occupied I/O points	8 points in total (including input points and output points)

6.3 Performance specifications

Item	Description
Control method	Two-position control, PID control (with auto tuning function), PI control
Control operation period	500ms
Set temperature range	Equivalent to input range
Heater disconnection detection	Alarm is detected by buffer memory (Variable within range from 0.0 to 100.0 A.).
Operation mode	0: Measured value monitor 1: Measured value monitor + Temperature alarm 2: Measured value monitor + Temperature alarm + Control (selected by buffer memory)
Self-diagnosis function	Adjustment data check, input value check, watch dog timer check.
Memory	Built-in EEPROM (Number of times of overwrite: 100,000 times)
Indication	POWER Lit (green): While 5V power is supplied Extinguished: While 5V power is not supplied
	24V Lit (red): While 24V power is supplied Extinguished: While 24V power is not supplied
	OUT1 Lit (red): While control output 1 is ON Extinguished: While control output 1 is OFF
	OUT2 Lit (red): While control output 2 is ON Extinguished: While control output 2 is OFF

6.4 Input specifications

Item	Description	
Number of input points	2 points	
	Input type	Thermocouple K, J, R, S, E, T, B, N, PLII, WRe5-26, U, L, JIS C 1602-1995 Resistance thermometer bulb 3-wire Pt100 JIS C 1604-1997, JPt100 JIS C 1604-1981
Measurement precision	Ambient temperature 23 °C ± 5 °C : ± 0.3% of range span ± 1 digit. Ambient temperature 0 °C to 55 °C : ± 0.7% of range span ± 1 digit. However, 0 to 399 °C (0 to 799 °F) in B inputs as well as 0 to 32 °F in PLII and WRe5-26 inputs are outside precision guarantee range.	
Cold contact temperature compensation error	Within ±1.0 °C However, within ± 2.0 °C while input value is -150 to -100 °C within ± 3.0 °C while input value is -200 to -150 °C	
Resolution	0.1 °C (0.1 °F) or 1 °C (1 °F) (Varies depending on input range of used sensors.)	
Sampling period	500ms	
Effect of external resistance	Approx. 0.35 μV/Ω	
Input impedance	1 MΩ or more	
Sensor current	Approx. 0.3 mA	
Allowable input lead wire resistance	10 Ω or less	
Operation when input is disconnected	Upscale	
Operation when input is short-circuited	Downscale	
CT input	Number of inputs	2 points
	Current detector	CTL-12-S36-8 or CTL-6-P-H (manufactured by U.R.D. Co., Ltd.)
	Heater current measurement value	When CTL-12 is used: 0 to 100A When CTL-6 is used: 0 to 30A
	Measurement precision	Larger one between ± 5% of input value and 2 A (excluding precision of current detector)
Sampling period	1 second	

6.5 Input range

Sensor type	K	J	R	S
Input range	-200.0 to 200.0 °C	-200.0 to 200.0 °C	0 to 1700 °C 0 to 3200 °F	0 to 1700 °C 0 to 3200 °F
	-100.0 to 400.0 °C	-100.0 to 400.0 °C		
	-100 to 1300 °C	-100.0 to 800.0 °C		
	-100 to 800 °F	-100 to 1200 °C		
	-100 to 2400 °F	-100 to 1600 °F -100 to 2100 °F		

Sensor type	E	T	B	N
Input range	-200.0 to 200.0 °C	-200.0 to 200.0 °C	0 to 1800 °C 0 to 3000 °F	0 to 1300 °C 0 to 2300 °F
	0 to 1000 °C	-200.0 to 400.0 °C		
	0 to 1800 °F	0 to 400.0 °C		
		-300.0 to 400.0 °F		
		-300.0 to 700.0 °F 0.0 to 700.0 °F		

Sensor type	PLII	WRe5-26	U	L
Input range	0 to 1200 °C	0 to 2300 °C	-200.0 to 600.0 °C -300.0 to 700.0 °F	0.0 to 900.0 °C 0 to 1600 °F
	0 to 2300 °F	0 to 3000 °F		

Sensor type	JPt100	Pt100
Input range	-50.0 to 150.0 °C	-50.0 to 150.0 °C
	-200.0 to 500.0 °C	-200.0 to 600.0 °C
	-300.0 to 300.0 °F	-300.0 to 300.0 °F
	-300 to 900 °F	-300 to 1100 °F

- When B is used, 0 to 399 °C (0 to 799 °F) is outside the precision guarantee range.
- When PLII is used, 0 to 32 °F is outside the precision guarantee range.
- When WRe5-26 is used, 0 to 32 °F is outside the precision guarantee range.

6.6 Output specifications

Item	Description
Number of output points	2 points
Output method	Open collector transistor output
Rated load voltage	5 to 24V DC
Maximum load voltage	30V DC or less
Maximum load current	100mA
Leak current in OFF status	0.1 mA or less
Maximum voltage drop in ON status	2.5V (maximum) or 1.0V (typical) at 100 mA
Control output cycle	30 seconds (Variable within range from 1 to 100 seconds)

Guidelines for the safety of the user and protection of the FX2N-2LC

- This manual has been written to be used by trained and competent personnel. This is defined by the European directives for machinery, low voltage and EMC.
- If in doubt at any stage during the installation of the FX2N-2LC always consult a professional electrical engineer who is qualified and trained to the local and national standards. If in doubt about the operation or use of the FX2N-2LC please consult the nearest Mitsubishi Electric distributor.
- Under no circumstances will Mitsubishi Electric be liable or responsible for any consequential damage that may arise as a result of the installation or use of this equipment.
- All examples and diagrams shown in this manual are intended only as an aid to understanding the text, not to guarantee operation. Mitsubishi Electric will accept no responsibility for actual use of the product based on these illustrative examples.
- Owing to the very great variety in possible application of this equipment, you must satisfy yourself as to its suitability for your specific application.

Manual number : JY992D85601

Manual revision : C

Date : March 2007

MITSUBISHI ELECTRIC CORPORATION

HEAD OFFICE : TOKYO BUILDING, 2-7-3 MARUNOUCHI, CHIYODA-KU, TOKYO 100-8310, JAPAN
HIMEJI WORKS : 840, CHIYODA CHO, HIMEJI, JAPAN

JY992D85601C

Effective March 2007
Specifications are subject to change without notice