



PROGRAMMABLE CONTROLLERS

FX3S SERIES PROGRAMMABLE CONTROLLERS

HARDWARE MANUAL



Manual Number	JY997D48301
Revision	B
Date	September 2013

This manual describes the part names, dimensions, mounting, cabling and specifications for the product. This manual is extracted from FX3S Series User's Manual - Hardware Edition. Refer to FX3S Series User's Manual - Hardware Edition for more details. Before use, read this manual and manuals of relevant products fully to acquire proficiency in the handling and operating the product. Make sure to learn all the product information, safety information, and precautions.

And, store this manual in a safe place so that you can take it out and read it whenever necessary. Always forward it to the end user.

Registration

The company name and the product name to be described in this manual are the registered trademarks or trademarks of each company.

Effective September 2013

Specifications are subject to change without notice.

© 2013 Mitsubishi Electric Corporation

Safety Precaution (Read these precautions before use.)

This manual classifies the safety precautions into two categories:

WARNING and **CAUTION**.

WARNING	Indicates that incorrect handling may cause hazardous conditions, resulting in death or severe injury.
CAUTION	Indicates that incorrect handling may cause hazardous conditions, resulting in medium or slight personal injury or physical damage.

Depending on the circumstances, procedures indicated by **CAUTION** may also cause severe injury. It is important to follow all precautions for personal safety.

STARTUP AND MAINTENANCE PRECAUTIONS	WARNING
<ul style="list-style-type: none"> Do not touch any terminal while the PLC's power is on. Doing so may cause electric shock or malfunctions. Before cleaning or retightening terminals, cut off all phases of the power supply externally. Failure to do so may cause electric shock. Before modifying or disrupting the program in operation or running the PLC, carefully read through this manual and the associated manuals and ensure the safety of the operation. An operation error may damage the machinery or cause accidents. 	

STARTUP AND MAINTENANCE PRECAUTIONS	CAUTION
<ul style="list-style-type: none"> Turn off the power to the PLC before attaching or detaching the memory cassette. If the memory cassette is attached or detached while the PLC's power is on, the data in the memory may be destroyed, or the memory cassette may be damaged. Do not disassemble or modify the PLC. Doing so may cause fire, equipment failures, or malfunctions. For repair, contact your local Mitsubishi Electric representative. 	

STARTUP AND MAINTENANCE PRECAUTIONS	CAUTION
<ul style="list-style-type: none"> Turn off the power to the PLC before connecting or disconnecting any connection cable. Failure to do so may cause equipment failures or malfunctions. Turn off the power to the PLC before attaching or detaching the following devices. Failure to do so may cause equipment failures or malfunctions. <ul style="list-style-type: none"> Peripheral devices, expansion boards, special adapters and memory cassette 	

DISPOSAL PRECAUTIONS	CAUTION
<ul style="list-style-type: none"> Please contact a certified electronic waste disposal company for the environmentally safe recycling and disposal of your device. 	

TRANSPORTATION AND STORAGE PRECAUTIONS	CAUTION
<ul style="list-style-type: none"> The PLC is a precision instrument. During transportation, avoid impacts larger than those specified in section 2.1. Failure to do so may cause failures in the PLC. After transportation, verify the operations of the PLC. 	

Associated manuals

How to obtain manuals
For the necessary product manuals or documents, consult with your local Mitsubishi Electric representative.

Associated manuals
FX3S Series PLC (main unit) comes with this document (hardware manual). For a detailed explanation of the FX3S Series hardware and information on instructions for PLC programming, refer to the relevant documents.

Manual name	Manual No.	Description
FX3S Series User's Manual - Hardware Edition	JY997D48601 MODEL CODE: 09R535	Explains FX3S Series PLC specification details for I/O, wiring, installation, and maintenance.
FX3S/FX3G/FX3GC/FX3U/FX3UC Series Programming Manual - Basic & Applied Instruction Edition	JY997D16601 MODEL CODE: 09R517	Describes PLC programming for basic/applied instructions STL/SFC programming and devices.
MELSEC-Q/L/F Structured Programming Manual (Fundamentals)	SH-080782 MODEL CODE: 13JW06	Programming methods, specifications, functions, etc. required to create structured programs.
FXCPU Structured Programming Manual [Device & Common]	JY997D26001 MODEL CODE: 09R925	Devices, parameters, etc. provided in structured projects of GX Works2.
FXCPU Structured Programming Manual [Basic & Applied Instruction]	JY997D34701 MODEL CODE: 09R926	Sequence instructions provided in structured projects of GX Works2.
FXCPU Structured Programming Manual [Application Functions]	JY997D34801 MODEL CODE: 09R927	Application functions provided in structured projects of GX Works2.
FX Series User's Manual - Data Communication Edition	JY997D16901 MODEL CODE: 09R715	Explains N:N link, parallel link, computer link, no protocol communication by RS instructions/FX2N-232IF.
FX3S/FX3G/FX3GC/FX3U/FX3UC Series User's Manual - Analog Control Edition	JY997D16701 MODEL CODE: 09R619	Describes specifications for analog control and programming methods for FX3S/FX3G/FX3GC/FX3U/FX3UC Series PLC.
FX3S/FX3G/FX3GC/FX3U/FX3UC Series User's Manual - Positioning Control Edition	JY997D16801 MODEL CODE: 09R620	Explains the specifications for positioning control of FX3S/FX3G/FX3GC/FX3U/FX3UC Series and programming procedures.

Certification of UL, cUL standards

Please consult with Mitsubishi Electric for information on UL, cUL standard practices and the corresponding types of equipment.

Compliance with EC directive (CE Marking)

This document does not guarantee that a mechanical system including this product will comply with the following standards. Compliance to EMC directive and LVD directive of the entire mechanical system should be checked by the user/manufacturer. For more details please contact the local Mitsubishi Electric sales site.

Requirement for Compliance with EMC directive

The following products have shown compliance through direct testing (of the identified standards below) and design analysis (through the creation of a technical construction file) to the European Directive for Electromagnetic Compatibility (2004/108/EC) when used as directed by the appropriate documentation.

Attention

- This product is designed for use in industrial applications.

Note

- Manufactured by: Mitsubishi Electric Corporation 2-7-3 Marunouchi, Chiyoda-ku, Tokyo, 100-8310 Japan
- Manufactured at: Mitsubishi Electric Corporation Himeji Works 840 Chiyoda-machi, Himeji, Hyogo, 670-8677 Japan
- Authorized Representative in the European Community: Mitsubishi Electric Europe B.V. Gothaer Str. 8, 40880 Ratingen, Germany

Type: Programmable Controller (Open Type Equipment)
Models: MELSEC FX3S series, FX3G series, FX3U series manufactured from June 1st, 2005

from June 1st, 2005	FX3U-232ADP FX3U-4AD-ADP FX3U-4AD-PT-ADP FX3U-232ADP-MB FX3U-4AD-PTW-ADP	FX3U-485ADP FX3U-4DA-ADP FX3U-4AD-TC-ADP FX3U-485ADP-MB FX3U-4AD-PNK-ADP
from April 1st, 2007 from December 1st, 2007 from November 1st, 2008	FX3G-232-BD FX3G-485-BD FX3G-2AD-BD FX3G-8AV-BD FX3U-3A-ADP	FX3G-422-BD FX3G-EEPROM-32L FX3G-1DA-BD

from June 1st, 2009
from February 1st, 2012
from March 1st, 2013

FX3S- ** MR/ES FX3S- ** MT/ESS Where ** indicates: 10,14,20,30	FX3S- ** MT/ES
FX3S- ** MR/DS FX3S- ** MT/DSS Where ** indicates: 10,14,20,30	FX3S- ** MT/DS
FX3G-4EX-BD FX3G-485-BD-RJ	FX3G-2EYT-BD

Standard	Remark
EN61131-2: 2007 Programmable controllers - Equipment requirements and tests	Compliance with all relevant aspects of the standard. EMI <ul style="list-style-type: none"> Radiated Emission Conducted Emission EMS <ul style="list-style-type: none"> Radiated electromagnetic field Fast transient burst Electrostatic discharge High-energy surge Voltage drops and interruptions Conducted RF Power frequency magnetic field

Requirement for Compliance with LVD directive

The following products have shown compliance through direct testing (of the identified standards below) and design analysis (through the creation of a technical construction file) to the European Directive for Low Voltage (2006/95/EC) when used as directed by the appropriate documentation.

Type: Programmable Controller (Open Type Equipment)
Models: MELSEC FX3S series manufactured from March 1st, 2013
FX3S- ** MR/ES
FX3S- ** MT/ESS
Where ** indicates: 10,14,20,30

from September 1st, 2013
FX3S- ** MR/DS
Where ** indicates: 10,14,20,30

Standard	Remark
EN61131-2: 2007 Programmable controllers - Equipment requirements and tests	The equipment has been assessed as a component for fitting in a suitable enclosure which meets the requirements of EN61131-2: 2007

Caution for compliance with EC Directive

Installation in Enclosure

Programmable logic controllers are open-type devices that must be installed and used within conductive control boxes. Please use the FX3S Series programmable logic controllers while installed in conductive shielded control boxes. Please secure the control box lid to the control box (for conduction). Installation within a control box greatly affects the safety of the system and aids in shielding noise from the programmable logic controller.

Incorporated Items

Check if the following product and items are included in the package:

	Included Items	
FX3S-10M□	Product	1 unit
FX3S-14M□	Dust protection sheet	1 sheet
FX3S-20M□		
FX3S-30M□	Manuals [Japanese/English]	1 manual

1. Outline

1.1 Part names

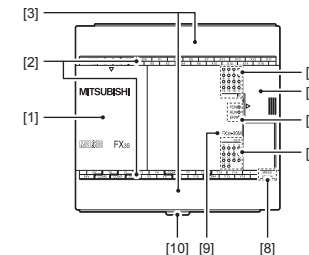

No.	Name
[1]	Top cover
[2]	Terminal names
[3]	Terminal block covers
[4]	Input display LEDs (red)
[5]	Peripheral device connecting connector cover

No.	Name		
	Operation status display LEDs		
	POW	Green	On while power is on the PLC.
[6]	RUN	Green	On while the PLC is running.
	ERR	Red	Flashing when a program error occurs.
		Red	Lights when a CPU error occurs.
[7]	Output display LEDs (red)		
[8]	The year and month of production		
[9]	Model name (abbreviation)		
[10]	DIN rail mounting hooks		

When the top covers are open

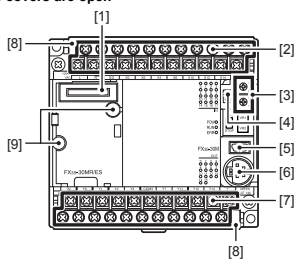

No.	Name
[1]	Optional equipment connector
[2]	Power supply terminal, Input (X) terminals
[3]	Variable analog potentiometers Upper side: VR1, Lower side: VR2
[4]	RUN/STOP switch
[5]	Peripheral device connecting connector (USB)
[6]	Peripheral device connecting connector (RS-422)
[7]	Service power supply terminal (AC power type only), Output (Y) terminals
[8]	Terminal cover
[9]	Optional equipment connecting screw holes

Right side

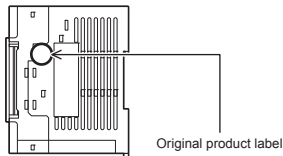

The original product label is affixed to the right side of the product. Product without the original product label is not covered by warranty.

1.2 External dimensions and weight

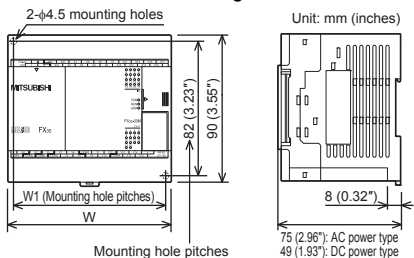

Model name	W: mm (inches)	W1: mm (inches) Direct mounting hole pitches	MASS (Weight): kg (lbs)	
			AC power type	DC power type
FX3S-10M□	60 (2.37")	52 (2.05")	0.30 (0.66 lbs)	0.22 (0.48 lbs)
FX3S-14M□	60 (2.37")	52 (2.05")	0.30 (0.66 lbs)	0.22 (0.48 lbs)
FX3S-20M□	75 (2.96")	67 (2.64")	0.40 (0.88 lbs)	0.30 (0.66 lbs)
FX3S-30M□	100 (3.94")	92 (3.63")	0.45 (0.99 lbs)	0.35 (0.77 lbs)

Installation

- 35-mm-wide DIN rail or Direct (screw) mounting (M4×2)

2. Installation (general specifications)

As for installation of the special adapters and expansion boards, refer to the following manual.

→ Refer to FX3S Series User's Manual - Hardware Edition.

CAUTION

INSTALLATION PRECAUTIONS

- Use the product within the generic environment specifications described in section 2.1 of this manual.
- Never use the product in areas with excessive dust, oily smoke, conductive dusts, corrosive gas (salt air, Cl₂, H₂S, SO₂ or NO₂), flammable gas, vibration or impacts, or expose it to high temperature, condensation, or rain and wind.
- If the product is used in such conditions, electric shock, fire, malfunctions, deterioration or damage may occur.
- Do not touch the conductive parts of the product directly. Doing so may cause device failure or malfunctions.
- Install the product securely using a DIN rail or mounting screws.
- Install the product on a flat surface.
- If the mounting surface is rough, undue force will be applied to the PC board, thereby causing nonconformities.
- When drilling screw holes or wiring, make sure cutting or wire debris do not enter the ventilation slits.
- Failure to do so may cause fire, equipment failures or malfunctions.
- Be sure to remove the dust proof sheet from the PLC's ventilation port when installation work is completed. Failure to do so may cause fire, equipment failures or malfunctions.
- Connect the peripheral device cables securely to their designated connectors. Loose connections may cause malfunctions.
- Turn off the power to the PLC before attaching or detaching the following devices. Failure to do so may cause device failures or malfunctions.
 - Peripheral devices, expansion boards, special adapters and memory cassette

Notes

- When a dust proof sheet is supplied with units, keep the sheet applied to the ventilation slits during installation and wiring work.
- To prevent temperature rise, do not install the PLC on a floor, a ceiling or a vertical surface.
- Install it horizontally on a wall as shown in section 2.2.
- Keep a space of 50 mm (1.97") or more between the unit main body and another device or structure (part A). Install the unit as far away as possible from high-voltage lines, high-voltage devices and power equipment.

WARNING

WIRING PRECAUTIONS

- Make sure to cut off all phases of the power supply externally before attempting installation or wiring work.
- Failure to do so may cause electric shock or damage to the product.

2.1 Generic specifications

Item	Specification			
Ambient temperature	0 to 55 °C (32 to 131 °F) when operating and -25 to 75 °C (-13 to 167 °F) when stored			
Ambient humidity	5 to 95 %RH (no condensation) when operating			
Vibration resistance *1	When installed on DIN rail	Frequency (Hz)	Acceleration (m/s ²)	Half amplitude (mm)
		10 to 57	-	0.035
	When installed directly	57 to 150	4.9	-
		10 to 57	-	0.075
		57 to 150	9.8	-
Sweep Count for X, Y, Z: 10 times (80 min in each direction)				
Shock resistance *1	147 m/s ² Acceleration, Action time: 11 ms, 3 times by half-sine pulse in each direction X, Y, and Z			
Noise resistance	By noise simulator at noise voltage of 1,000 Vp-p, noise width of 1 μs, rise time of 1 ns and period of 30 to 100 Hz			
Dielectric withstand voltage	1.5 kV AC for 1 min	Between each terminals and ground terminal ²		
	500 V AC for 1 min			
Insulation resistance	5 MΩ or more by 500 V DC megger			
Grounding	Class D grounding (grounding resistance: 100 Ω or less) <Common grounding with a heavy electrical system is not allowed.> ³			
Working atmosphere	Free from corrosive or flammable gas and excessive conductive dusts			
Working altitude	<2000 m ⁴			

*1 The criterion is shown in IEC61131-2.

*2 Dielectric withstand voltage and insulation resistance are shown in the following table.

Terminal	Dielectric strength	Insulation resistance
■ Terminals of main units		
Between power supply terminal (AC power) and ground terminal	1.5 kV AC for 1 min	5 MΩ or more by 500 V DC megger
Between power supply terminal (DC power) and ground terminal	500 V AC for 1 min	
Between input terminal (24 V DC) and ground terminal	500 V AC for 1 min	
Between output terminal (relay) and ground terminal	1.5 kV AC for 1 min	
Between output terminal (transistor) and ground terminal	500 V AC for 1 min	
■ Terminals of expansion boards, special adapters		
Between terminal of expansion board and ground terminal	Not allowed	Not allowed
Between terminal of special adapter and ground terminal	500 V AC for 1 min	5 MΩ or more by 500 V DC megger

For dielectric with stand voltage test and insulation resistance test of each product, refer to the following manual.

→ Refer to FX3S Series User's Manual - Hardware Edition.

*3 For common grounding, refer to section 3.3.

*4 The PLC cannot be used at a pressure higher than the atmospheric pressure to avoid damage.

2.2 Installation location

Install the PLC in an environment conforming to the generic specifications (section 2.1), installation precautions and notes.

Installation location in enclosure

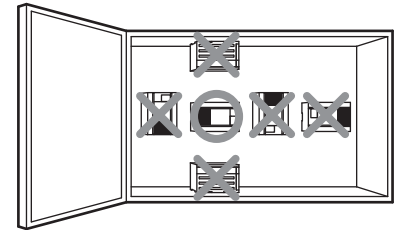

Space in enclosure

Special adapter can be connected on the left sides of the main unit. If you intend to add special adapter in the future, keep necessary spaces on the left sides.

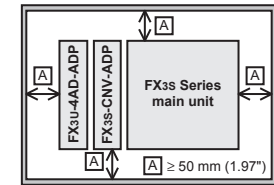

2.2.1 Affixing the dust proof sheet

The dust proof sheet should be affixed to the ventilation port before beginning the installation and wiring work. Be sure to remove the dust proof sheet when the installation and wiring work is completed.

→ For the affixing procedure, refer to the instructions on the dust proof sheet.

2.3 Procedures for installing to DIN rail

The products can be installed on a DIN46277 rail (35 mm (1.38") wide).

This section explains the installations of the main units.

For the special adapters, refer to the following manual.

→ Refer to FX3S Series User's Manual - Hardware Edition.

2.3.1 Installation

1) Push out all DIN rail mounting hooks (below fig. A).

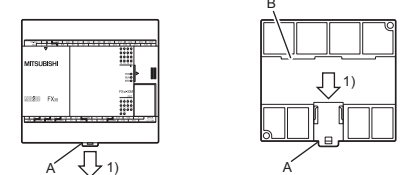

2) Fit the upper edge of the DIN rail mounting groove (right fig. B) onto the DIN rail.

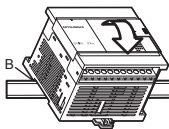

3) Lock the DIN rail mounting hooks (below fig. C) while pressing the PLC against the DIN rail.

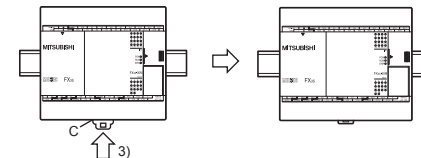

2.4 Procedures for installing directly (with M4 screws)

The product can be installed directly on the panel (with screws). This section explains the installation of the main units.

For the special adapters, refer to the following manual.

→ Refer to FX3S Series User's Manual - Hardware Edition.

2.4.1 Mounting hole pitches

Refer to the External Dimensions (section 1.2) for the product's mounting hole pitch information.

2.4.2 Installation

- 1) Make mounting holes in the mounting surface referring to the external dimensions diagram.
- 2) Fit the main unit (A in the right figure) based on the holes, and secure it with M4 screws (B in the right figure).

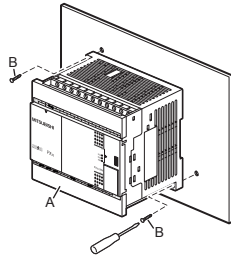

3. Power supply/input/output specifications and examples of external wiring

For the details refer to the following manual.

→ Refer to FX3S Series User's Manual - Hardware Edition.

DESIGN PRECAUTIONS **WARNING**

- Make sure to have the following safety circuits outside of the PLC to ensure safe system operation even during external power supply problems or PLC failure. Otherwise, malfunctions may cause serious accidents.

- 1) Most importantly, have the following: an emergency stop circuit, a protection circuit, an interlock circuit for opposite movements (such as normal vs. reverse rotation), and an interlock circuit (to prevent damage to the equipment at the upper and lower positioning limits).
- 2) Note that when the PLC CPU detects an error, such as a watchdog timer error, during self-diagnosis, all outputs are turned off. Also, when an error that cannot be detected by the PLC CPU occurs in an input/output control block, output control may be disabled. External circuits and mechanisms should be designed to ensure safe machinery operation in such a case.
- 3) If an overload of the 24 V DC service power supply occurs, the voltage automatically drops, inputs in the PLC are disabled, and all outputs are turned off. External circuits and mechanisms should be designed to ensure safe machinery operation in such a case.
- 4) Note that when an error occurs in a relay or transistor output device, the output could be held either on or off. For output signals that may lead to serious accidents, external circuits and mechanisms should be designed to ensure safe machinery operation in such a case.

DESIGN PRECAUTIONS **CAUTION**

- Do not bundle the control line together with or lay it close to the main circuit or power line. As a guideline, lay the control line at least 100 mm (3.94") or more away from the main circuit or power line. Noise may cause malfunctions.
- Install module so that excessive force will not be applied to peripheral device connectors. Failure to do so may result in wire damage/breakage or PLC failure.

Notes

- Even if the AC power supply causes an instantaneous power failure for less than 10 ms, the PLC can continue to operate.
- Even if the DC power supply causes an instantaneous power failure for less than 5 ms, the PLC can continue to operate.
- If a long-time power failure or an abnormal voltage drop occurs, the PLC stops, and output is turned off. When the power supply is restored, it will automatically restart (when the RUN input is on).

WIRING PRECAUTIONS **WARNING**

- Make sure to cut off all phases of the power supply externally before attempting installation or wiring. Failure to do so may cause electric shock or damage to the product.

WIRING PRECAUTIONS **CAUTION**

- Connect the power supply wiring to the dedicated terminals described in this manual. If an AC power supply is connected to a DC input/output terminal or DC power supply terminal, the PLC will burn out.
- Noise resistance may be lower when the L and N wires of an AC power supply are not wired correctly. Please wire using the correct polarity.
- Do not wire vacant terminals externally. Doing so may damage the product.
- Perform class D grounding (grounding resistance: 100 Ω or less) to the grounding terminal on the main unit with a wire 2 mm² or thicker. Do not use common grounding with heavy electrical systems (refer to section 3.3).
- When drilling screw holes or wiring, make sure cutting or wire debris does not enter the ventilation slits. Failure to do so may cause fire, equipment failures or malfunctions.
- Make sure to properly wire to the main unit in accordance with the following precautions. Failure to do so may cause electric shock, equipment failures, a short-circuit, wire breakage, malfunctions, or damage to the product.
 - Make sure to properly wire to the main unit in accordance with the rated voltage, current, and frequency of each terminal.
 - The disposal size of the cable end should follow the dimensions described in the manual.
 - Tightening torque should follow the specifications in the manual.

Notes

- Input/output wiring 50 to 100 m (164'1" to 328'1") long will cause almost no problems of noise, but, generally, the wiring length should be less than 20 m (65'7") to ensure the safety.

3.1 Wiring

3.1.1 Cable end treatment and tightening torque

For the terminals of FX3S series PLC, M3 screws are used. The electric wire ends should be treated as shown below. Tighten the screws to a torque of 0.5 to 0.8 N•m. Do not tighten terminal screws exceeding the specified torque. Failure to do so may cause equipment failures or malfunctions.

- When one wire is connected to one terminal

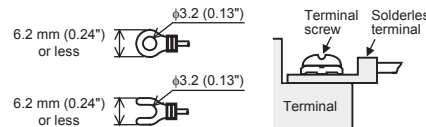

<Reference>

Terminal Manufacturer	Type No.	Certification	Pressure Bonding Tool
J.S.T. Mfg. Co., Ltd.	FV1.25-B3A	UL Listed	YA-1 (JST)
	FV2-MS3		

- When two wires are connected to one terminal

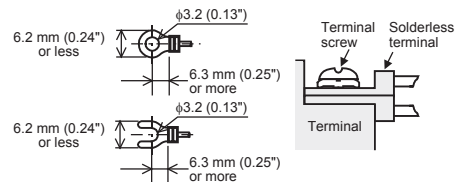

<Reference>

Terminal Manufacturer	Type No.	Certification	Pressure Bonding Tool
J.S.T. Mfg. Co., Ltd.	FV1.25-B3A	UL Listed	YA-1 (JST)

3.2 Power supply specifications and example of external wiring

For details, refer to the following manual.

→ Refer to FX3S Series User's Manual - Hardware Edition.

3.2.1 Power supply specifications

Item	Specification		
	AC power type	DC power type	
Supply voltage	100 to 240 V AC	24 V DC	
Allowable supply voltage range	85 to 264 V AC	20.4 to 26.4 V DC	
Rated frequency	50/60 Hz	-	
Allowable instantaneous power failure time	Operation can be continued upon occurrence of instantaneous power failure for 10 ms or less.	Operation can be continued upon occurrence of instantaneous power failure for 5 ms or less.	
Power fuse	250 V 1 A	250 V 1.6 A	
Rush current	15 A max. 5 ms or less/100 V AC	20 A max. 1 ms or less/24 V DC	
	28 A max. 5 ms or less/200 V AC		
Power consumption ¹⁾	FX3S-10M□	19 W	6 W
	FX3S-14M□	19 W	6.5 W
	FX3S-20M□	20 W	7 W
	FX3S-30M□	21 W	8.5 W
24 V DC service power supply	400 mA	-	-

¹⁾ This item shows values when all 24 V DC service power supplies are used in the maximum configuration connectable to the main unit, and includes the input current (5 or 7 mA per point). (The DC power type main unit does not have a 24 V DC service power supply.)

3.2.2 Example of external wiring [AC power type]

100 to 240 V AC power is supplied to the main unit.

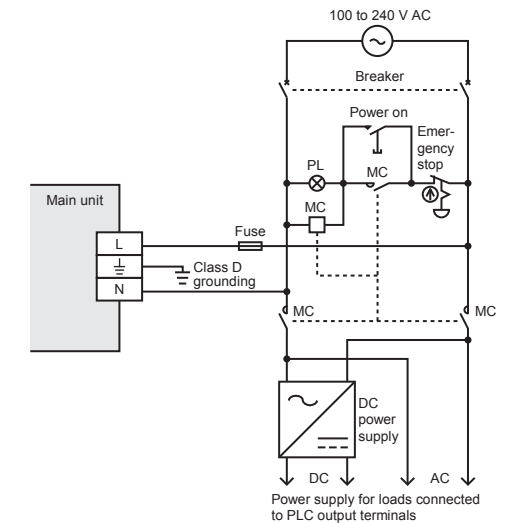

3.2.3 Example of external wiring [DC power type]

24 V DC power is supplied to the main unit.

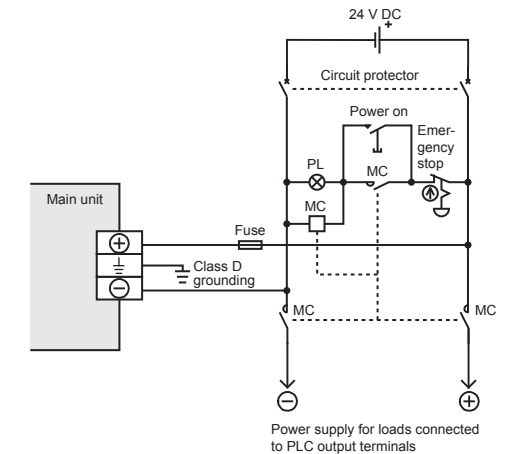

3.3 Grounding

Ground the PLC as stated below.

- Perform class D grounding. (Grounding resistance: 100 Ω or less)
- Ground the PLC independently if possible. If it cannot be grounded independently, ground it jointly as shown below.

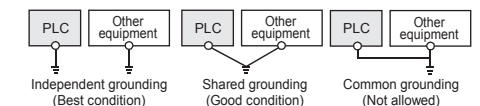

- Use ground wires thicker than AWG14 (2 mm²).
- Position the grounding point as close to the PLC as possible to decrease the length of the ground wire.

3.4 Input specifications and external wiring

For details, refer to the following manual.
 → Refer to FX3S Series User's Manual - Hardware Edition.

3.4.1 Input specifications

Item	Specification
Number of input points	FX3s-10M□ 6 points
	FX3s-14M□ 8 points
	FX3s-20M□ 12 points
	FX3s-30M□ 16 points
Input connecting type	Fixed terminal block (M3 screw)
Input form	Sink/Source
Input signal voltage	AC power type 24 V DC +10%, -10%
	DC power type 20.4 to 26.4 V DC
Input impedance	X000 to X007 3.3 kΩ
	X010 to X017 4.3 kΩ
Input signal current	X000 to X007 7 mA/24 V DC
	X010 to X017 5 mA/24 V DC
ON input sensitivity current	X000 to X007 4.5 mA or more
	X010 to X017 3.5 mA or more
OFF input sensitivity current	1.5 mA or less
Input response time	Approx. 10 ms
Input signal form	Sink input No-voltage contact input NPN open collector transistor
	Source input No-voltage contact input PNP open collector transistor
Input circuit insulation	Photocoupler insulation
Input operation display	LED on panel lights when photocoupler is driven.

3.4.2 Examples of input wiring [AC power type]

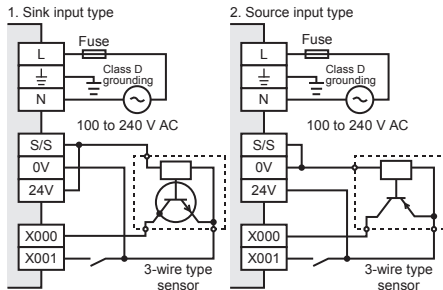

3.4.3 Examples of input wiring [DC power type]

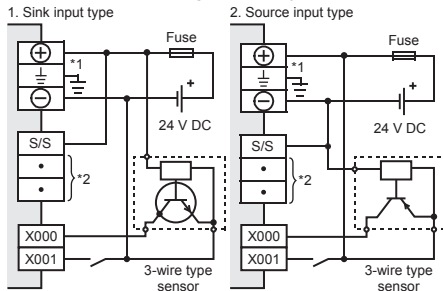

*1 Class D grounding.
 *2 Do not connect the [•] terminals with others, since they are not available.

3.4.4 Instructions for connecting input devices

As for the details of Instructions for connecting input devices, refer to the following manual.
 → Refer to FX3S Series User's Manual - Hardware Edition.

3.5 Relay output specifications and example of external wiring

For details, refer to the following manual.
 → Refer to FX3S Series User's Manual - Hardware Edition.

3.5.1 Relay output specifications

Item	Specification
Number of output points	FX3s-10MR□ 4 points
	FX3s-14MR□ 6 points
	FX3s-20MR□ 8 points
	FX3s-30MR□ 14 points
Output connecting type	Fixed terminal block (M3 screw)
Output form	Relay
External power supply	30 V DC or less
	240 V AC or less*1
Max. load	Resistance load 2 A/point*2
	Inductive load 80 VA*3
Min. load	5 V DC, 2 mA (reference value)
Open circuit leakage current	-
Response time	OFF→ON
	ON→OFF
Response time	Approx. 10 ms
Output circuit insulation	Mechanical insulation
Output operation display	LED on panel lights when power is applied to relay coil.

*1 250 V AC or less when the unit does not comply with CE, UL or cUL standards.
 *2 The total load current of resistance loads per common terminal should be the following value.
 - 1 output point/common terminal: 2 A or less
 - 4 output points/common terminal: 8 A or less
 As for the number of outputs per common terminal, refer to "Chapter 4 interpretation of partition" and the following manual.
 → Refer to FX3S Series User's Manual - Hardware Edition.
 *3 UL and cUL standards approved at 120 and 240 V AC.

3.5.2 Life of relay output contact

As for the details of life of relay output contact, refer to the following manual.
 → Refer to FX3S Series User's Manual - Hardware Edition.

3.5.3 Example of relay output wiring

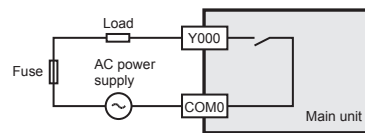

3.5.4 Cautions in external wiring

As for the details of cautions in external wiring, refer to the following manual.
 → Refer to FX3S Series User's Manual - Hardware Edition.

3.6 Transistor output specifications and example of external wiring

For details, refer to the following manual.
 → Refer to FX3S Series User's Manual - Hardware Edition.

3.6.1 Transistor output specifications

Item	Specification
Number of output points	FX3s-10MT□ 4 points
	FX3s-14MT□ 6 points
	FX3s-20MT□ 8 points
	FX3s-30MT□ 14 points
Output connecting type	Fixed terminal block (M3 screw)
Output form	FX3s-□MT/□S Transistor (Sink)
	FX3s-□MT/□SS Transistor (Source)
External power supply	5 to 30 V DC
Max. load	Resistance load 0.5 A/point*1
	Inductive load 12 W/24 V DC*2
Open circuit leakage current	0.1 mA or less/30 V DC
ON voltage	1.5 V or less
Response time	OFF→ON
	ON→OFF
Response time	Y000, Y001 5 μs or less/10 mA or more (5 to 24 V DC) Y002 to Y015 0.2 ms or less/200 mA or more (at 24 V DC)
Output circuit insulation	Photocoupler insulation
Output operation display	LED on panel lights when photocoupler is driven.

*1 The total load current of resistance loads per common terminal should be the following value.
 - 1 output point/common terminal: 0.5 A or less
 - 4 output points/common terminal: 0.8 A or less
 As for the number of outputs per common terminal, refer to "Chapter 4 interpretation of partition" and the following manual.
 → Refer to FX3S Series User's Manual - Hardware Edition.
 *2 The total of inductive loads per common terminal should be the following value.
 - 1 output point/common terminal: 12 W or less/24 V DC
 - 4 output points/common terminal: 19.2 W or less/24 V DC
 As for the number of outputs per common terminal, refer to "Chapter 4 interpretation of partition" and the following manual.
 → Refer to FX3S Series User's Manual - Hardware Edition.

3.6.2 External wiring of transistor output

1. External wiring of sink output type

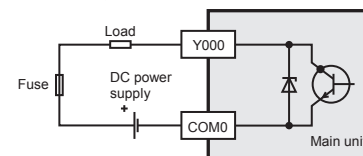

2. External wiring of source output type

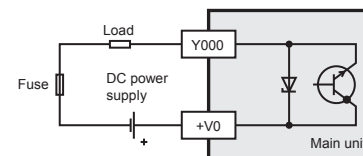

3.6.3 Cautions in external wiring

As for the details of cautions in external wiring, refer to the following manual.
 → Refer to FX3S Series User's Manual - Hardware Edition.

4. Terminal block layouts

For details on the terminal block layout, refer to the following manual.
 → Refer to FX3S Series User's Manual - Hardware Edition.

Interpretation of partition

The partition of the output terminals (see following figure) indicates the range of the output connected to the same common.

Example: FX3s-30MT/ES

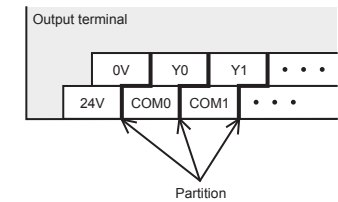

This manual confers no industrial property rights or any rights of any other kind, nor does it confer any patent licenses. Mitsubishi Electric Corporation cannot be held responsible for any problems involving industrial property rights which may occur as a result of using the contents noted in this manual.

Warranty

Mitsubishi will not be held liable for damage caused by factors found not to be the cause of Mitsubishi; opportunity loss or lost profits caused by faults in the Mitsubishi products; damage, secondary damage, accident compensation caused by special factors unpredictable by Mitsubishi; damages to products other than Mitsubishi products; and to other duties.

For safe use

- This product has been manufactured as a general-purpose part for general industries, and has not been designed or manufactured to be incorporated in a device or system used in purposes related to human life.
- Before using the product for special purposes such as nuclear power, electric power, aerospace, medicine or passenger movement vehicles, consult with Mitsubishi Electric.
- This product has been manufactured under strict quality control. However when installing the product where major accidents or losses could occur if the product fails, install appropriate backup or failsafe functions in the system.

MITSUBISHI ELECTRIC CORPORATION

HEAD OFFICE : TOKYO BUILDING, 2-7-3 MARUNOUCHI, CHIYODA-KU, TOKYO 100-8310, JAPAN
 HIMEJI WORKS : 840, CHIYODA CHO, HIMEJI, JAPAN